

INVITE NATURE INSIDE

TX 250A
TX 500A
TX 750A
TX 1000A

NOVEMBER 2016

TURBOVEX
- fresh air for everyone



TX COMFORT



A Decentralized ventilation system with a capacity from 250 to 1000 m³/h, can be used in the following locations:

- Schools
- Offices
- Meeting rooms
- Canteens
- Institutions
- Module construction

OPERATING PRINCIPLE

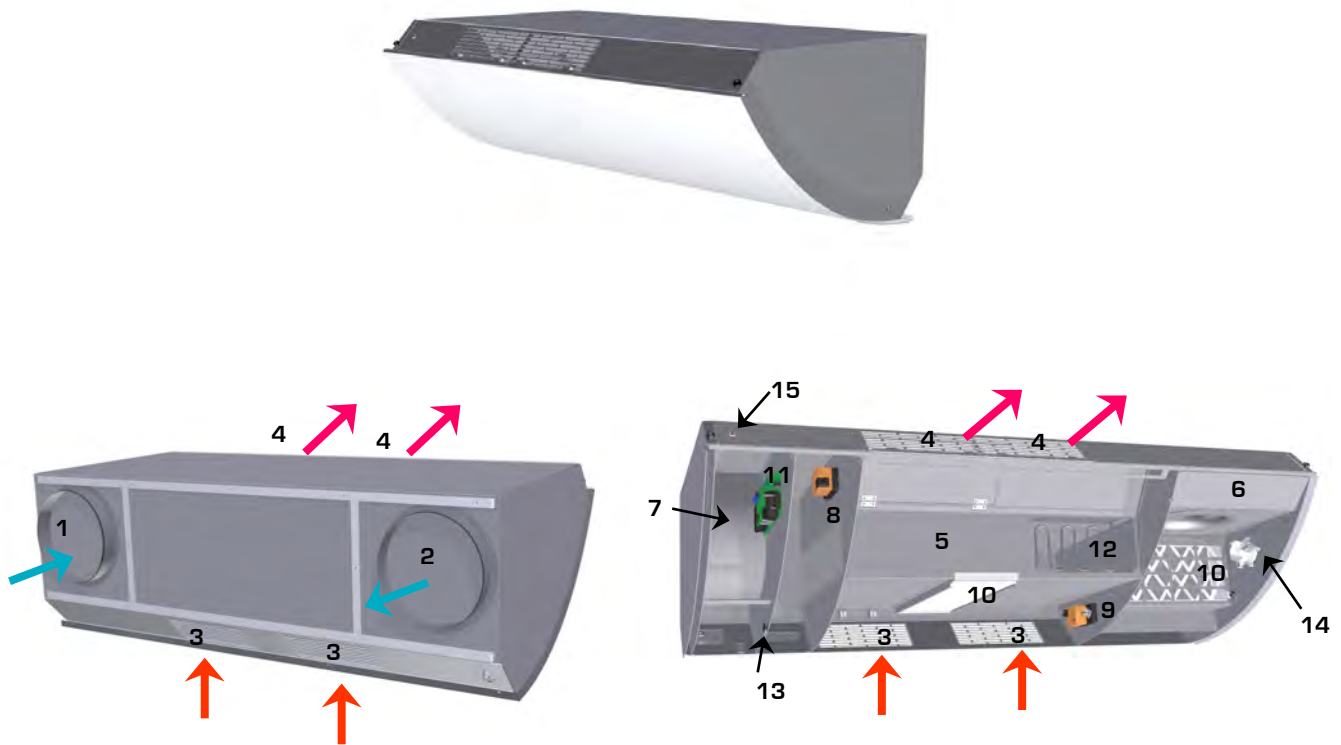

Turbovex TX Comfort is a decentralized ventilation system with built-in heat recovery for ventilation of comfort rooms, particular in indoor living spaces.

TX Comfort operates with an aluminium counter flow heat exchanger (5) to ensure maximum heat recovery. The unit utilizes warm indoor air to heat up inflowing fresh outdoor air. The counter flow heat exchanger's sole function is for heat retention.

Airflow:

The air supply ventilator (6) creates inflow of fresh outdoor air through the filter (10) leading the inflow through the heat exchanger (5) and further through the air supply grate (4) and out into the room. At the same time the air exhaust ventilator (7) creates outflow of indoor air leading it through the exhaust pipe (2) and further out to the open air outside.

The desired temperature of the air supply is regulated on the control panel. A sensor records the actual temperature of the flowing air supply. If the temperature is lower than the setpoint, the control system reduces the flow of the air supply warming it as it flows through the heat exchanger.

MAIN COMPONENTS

1.	Air supply	9.	Damper motor
2.	Air exhaust	10.	Filter
3.	Air exhaust grate	11.	Control board
4.	Air supply grate	12.	Heating surface (option)
5.	Counterflow exchanger	13.	Power switch
6.	Ventilator air supply	14.	Filter guard
7.	Ventilator air exhaust	15.	Filter alarm
8.	Bypass engine		

TECHNICAL SPECIFICATIONS

Unit:	TX 250A	TX 500A	TX 750A	TX 1000A	Unit
Dimension:					
S Length	1200	1550	1800	2100	mm
Depth	595	828	895	1050	mm
Height	403	493	565	665	mm
Duct:	2 x 160	2 x 250	2 x 315	2 x 315	mm
Weight:	35	57	99	122	Kg
Capacity:					
Min	100	300	350	500	m3/h
Max	250	500	750	1000	m3/h
Forced	480	800	1100	1600	m3/h
Sound:					
Min	26	25	25	27	dB(A)
Max	35	35	35	35	dB(A)
Forced	50	53	50	48	dB(A)
Filter:	F5	F5	F5	F5	Filter class
Energy consumption (motor):					
Min	12,6	9,8	28,5	14	Watts
	454	118	293	101	J/m3
Max	28	65	78	150	Watts
	403	468	374	540	J/m3
Forced	110	113,6	185	199	Watts
	825	511	605	448	J/m3
Output (motor):	2 x 71	2 x 90	2 x 170	2 x 175	Watts
Power supply:	1 x 230/50	1 x 230/50	1 x 230/50	1 x 230/50	Volt/Hz
Temperature efficiency:	80,6	84,5	78	80,6	%
Electric heating surface (option):	400	650	1000	1250	Watt
Water heating surface (option):	340	670	1260	1340	Watt

Air flow indicates the balanced air renewal in relation to the motor voltage and is stated as m³/h. Contact the distributor if the unit is to be used with forced operation.

The sound level is indicated in decibels [dB] in relation to the air renewal, measured at a distance of 1 meter in front of and 1 meter directly below the air supply grate. By way of comparison it may be mentioned that whispering corresponds to 30 dBA, ordinary spoken conversation corresponds to 60 dB and street traffic to about 90 dBA.

The temperature efficiency on the exchanger is indicated as a percentage [%] and is expressed as the ratio between the obtained temperature difference and the maximum achievable temperature difference.

FLOWCHART

FLOWCHART F. TURBOVEX DECENTRAL VENTILATION W. ELECTRONIC CONTROL

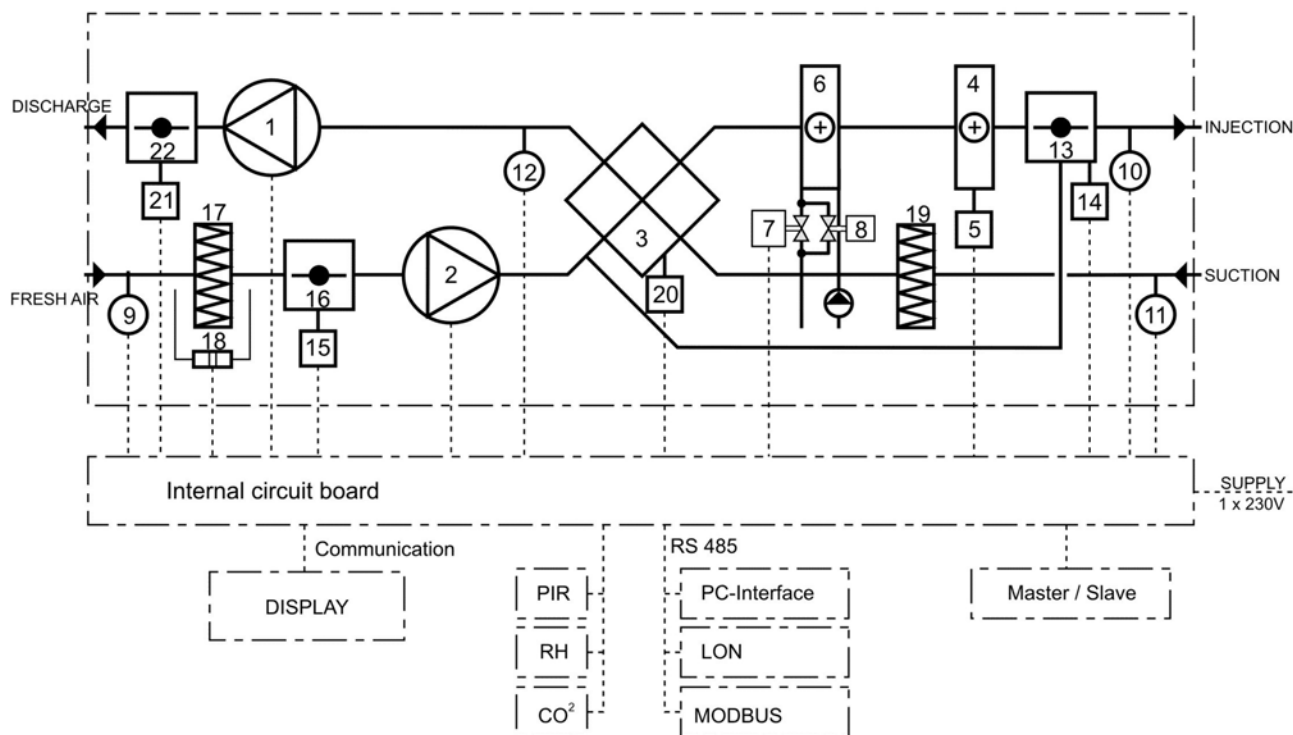

● STANDARD ○ OPTION

Pos. No	Components	TX 250A	TX 500A	TX 750A	TX 1000A	TX 3100A
1	Suction fan EC	●	●	●	●	●
2	Blower fan EC	●	●	●	●	●
3	Heat exchanger (air - air)	●	●	●	●	●
4	Heating surface	○	○	○	○	○
5	Fire-protection thermostat	○	○	○	○	○
6	Heating coil	○	○	○	○	○
7	Frost-protection thermostat	○	○	○	○	○
8	Control-valve	○	○	○	○	○
9	Freshair temperature-sensor	●	●	●	●	●
10	Injection temperature-sensor	●	●	●	●	●
11	Suction temperature-sensor	●	●	●	●	●
12	Discharge temperature-sensor	●	●	●	●	●
13	By-pass damper	●	●	●	●	●
14	Motor f. automatic By-pass	●	●	●	●	●
15	Motor f. internal damper	●	●	●	●	○
16	Internal damper	●	●	●	●	○
17	Filter Freshair M5	●	●	●	●	●
	Filter Freshair F7	○	○	○	○	○
18	Filter-alarm	●	●	●	●	●
19	Filter Discharge M5	●	●	●	●	●
20	Motor f. rotating exchanger / by-pass					●
21	Motor f. internal damper					●
22	Internal damper					●

DIMENSIONAL DRAWING

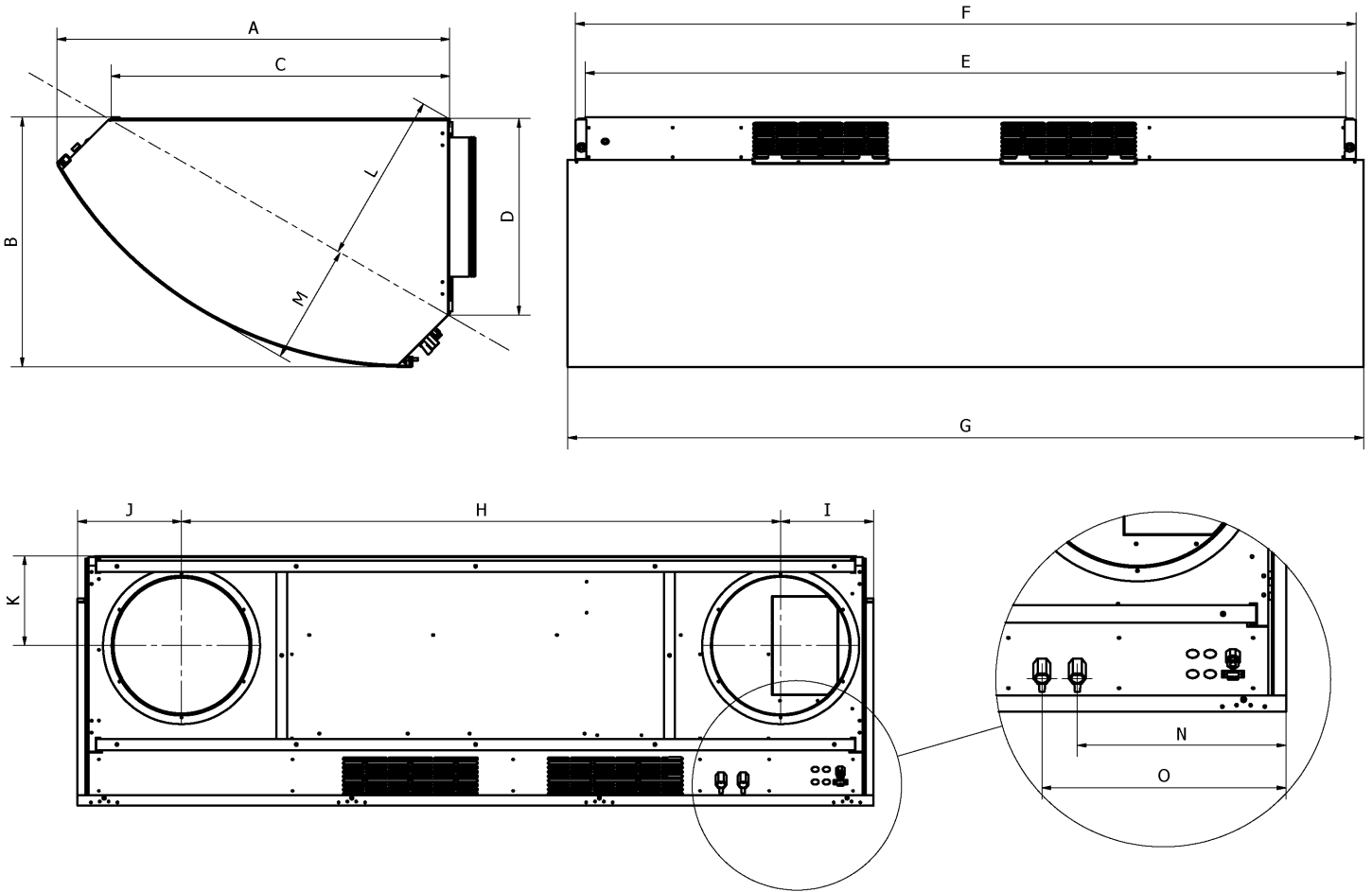

SIZE	TX 250A	TX 500A	TX 750A	TX 1000A
A	595	828	895	1050
B	403	493	565	665
C	500	710	766	917
D	313	382	442	542
E	1156	1506	1767	2067
F	1141	1491	1750	2050
G	1200	1550	1800	2100
H	906	1156	1355	1630
I	135	189	210	235
J	160	205	235	235
K	137	187	203	253
L	280	350	390	465
M	185	245	280	310
N	180	224	293	360
O	220	274	340	410

WATER HEATING SURFACE (OPTION)

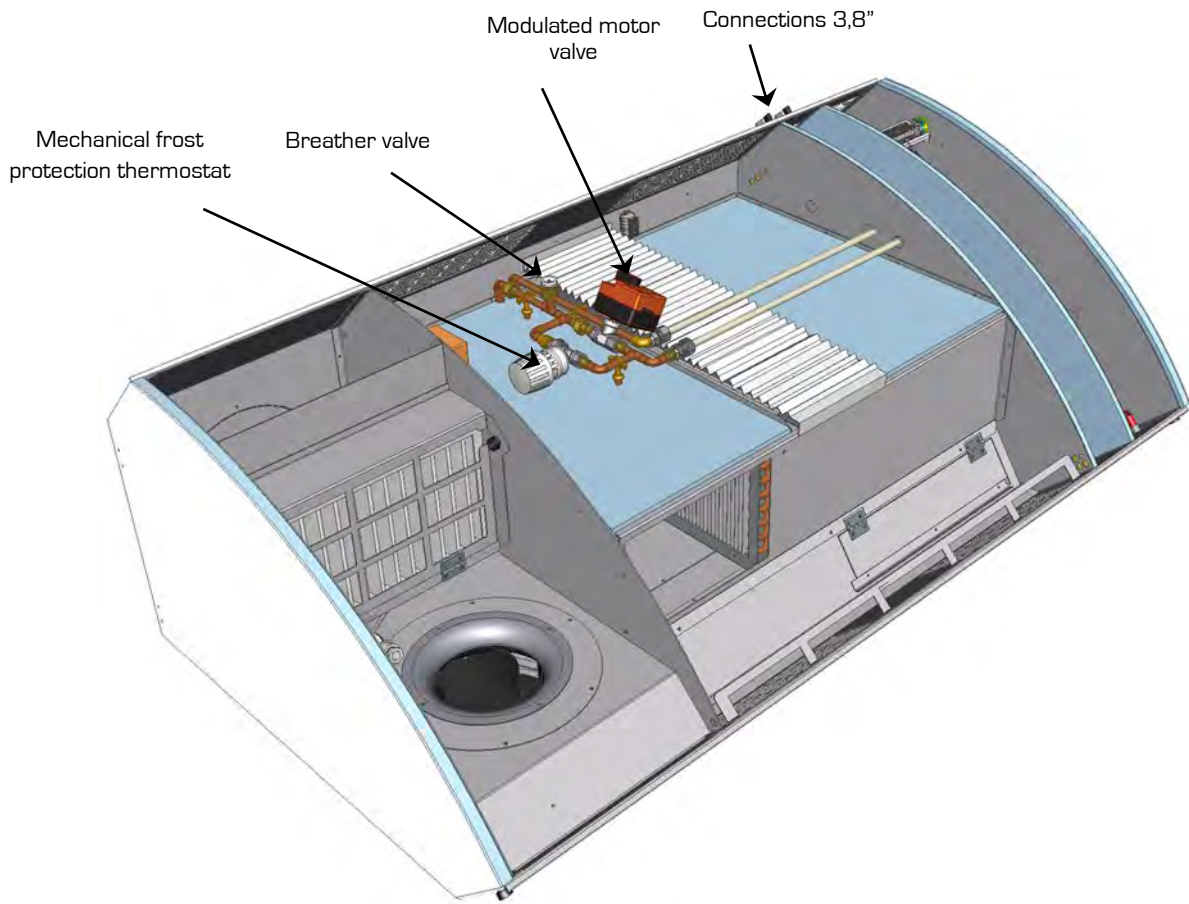

ELECTRIC HEATING SURFACE (OPTION)

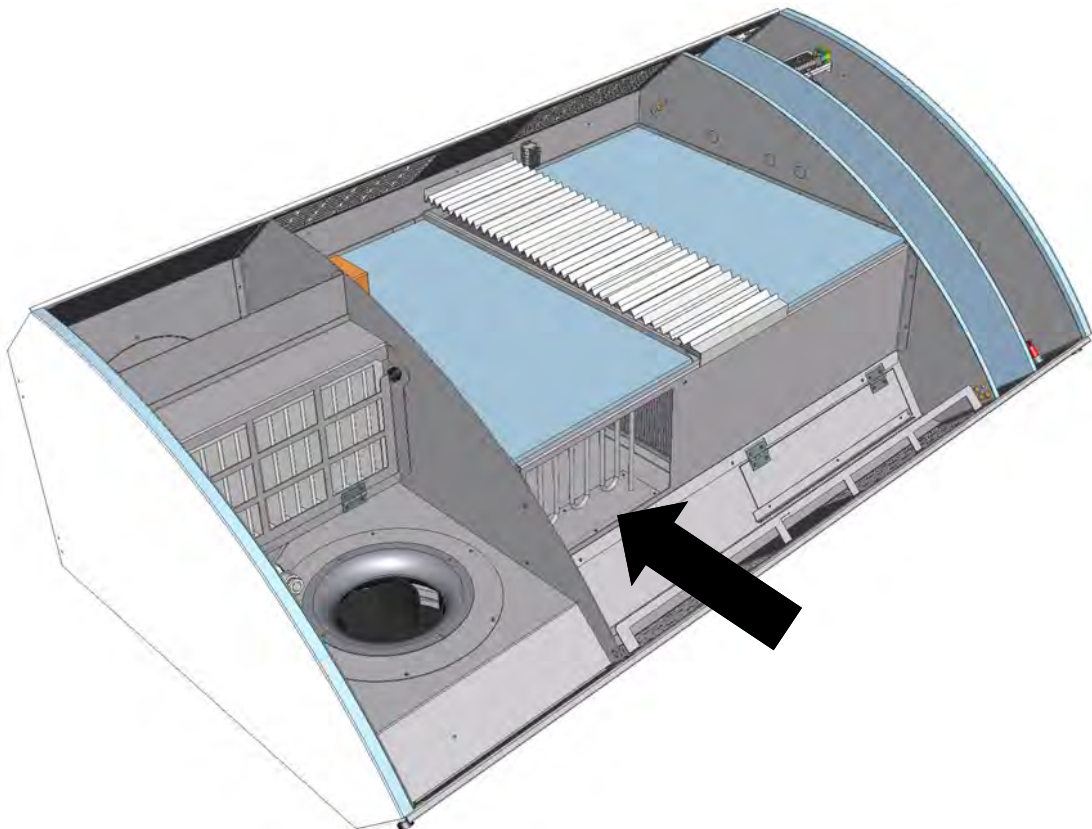

TX 250A

FLOW-SOUND-ENERGY

TX 250A (Flow - Sound - Energy)

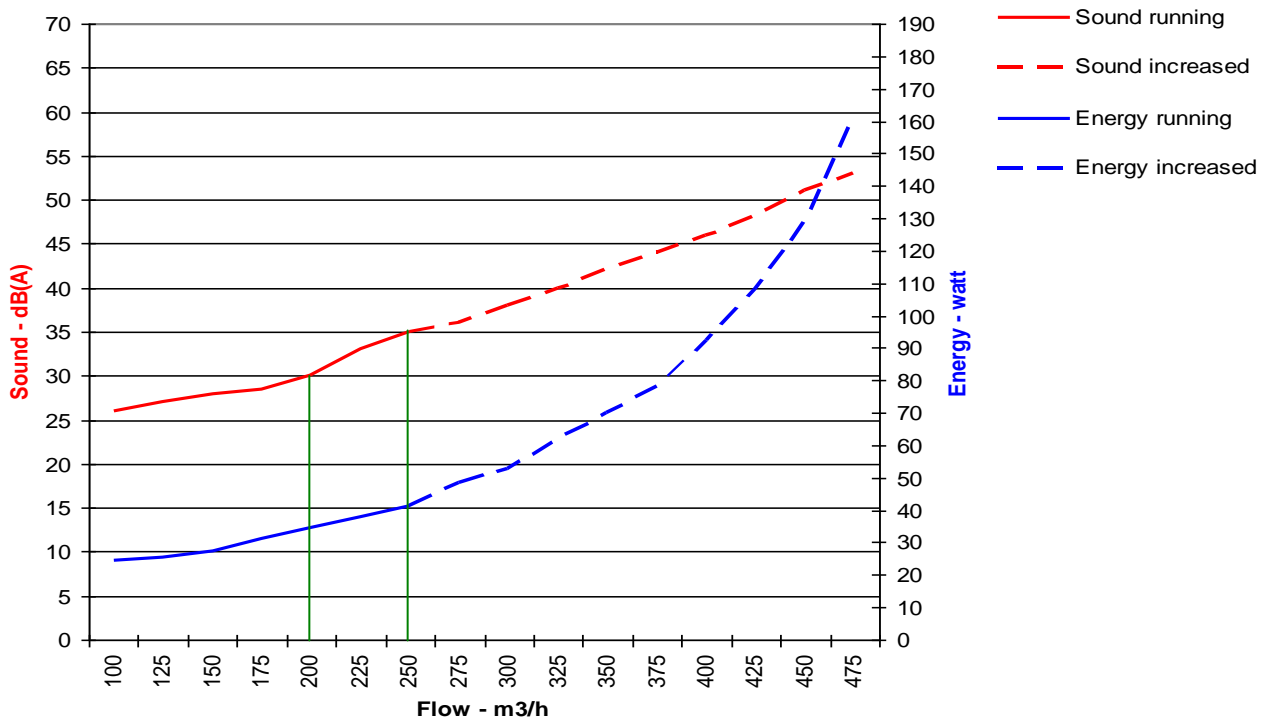

SUPPLY LENGTH

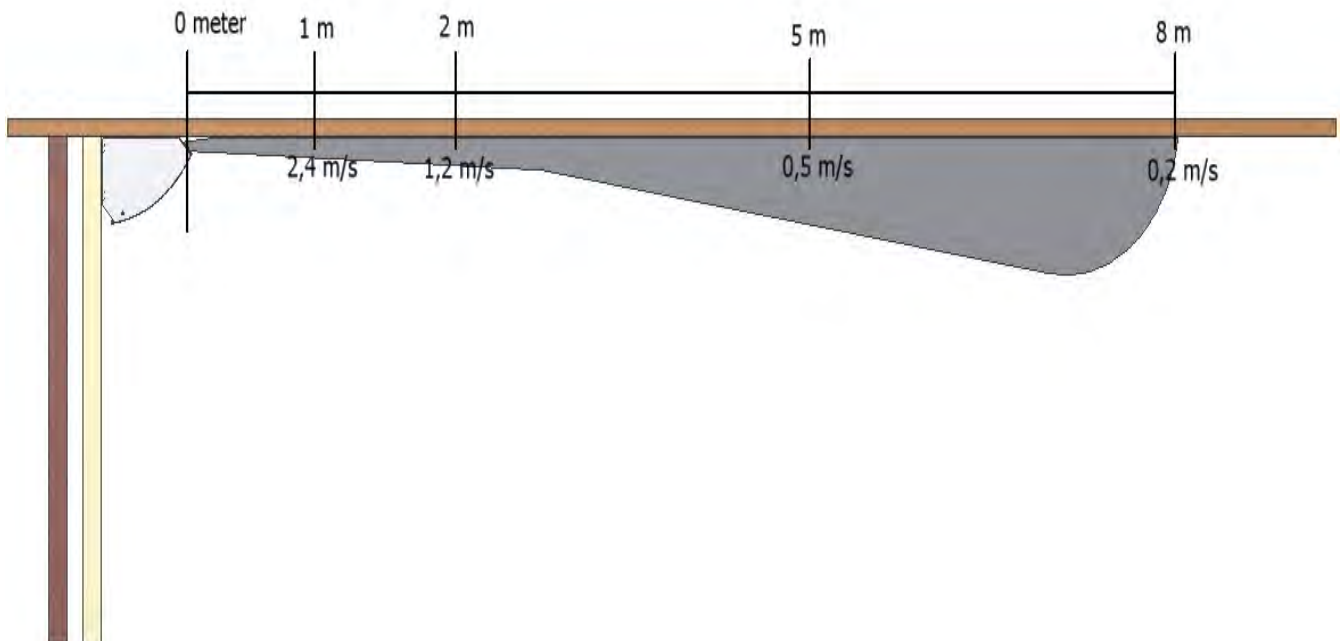

COUNTERFLOW EXCHANGER



TX 250A

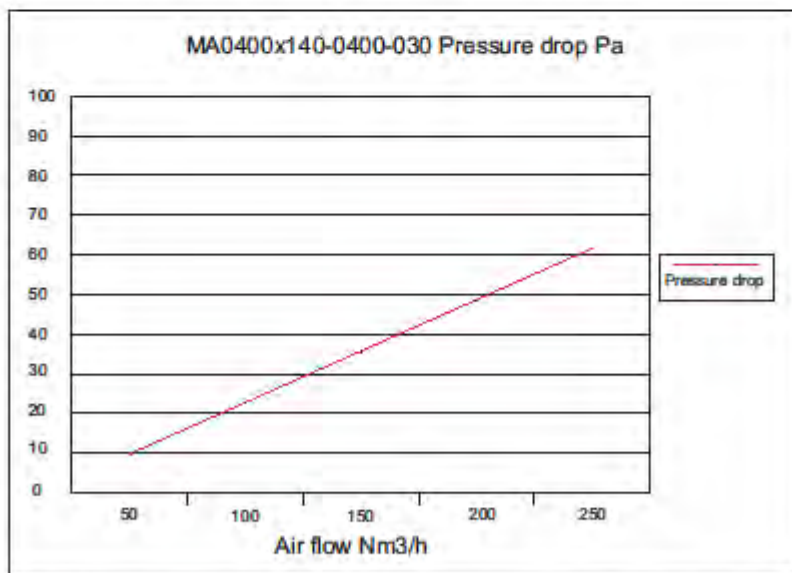
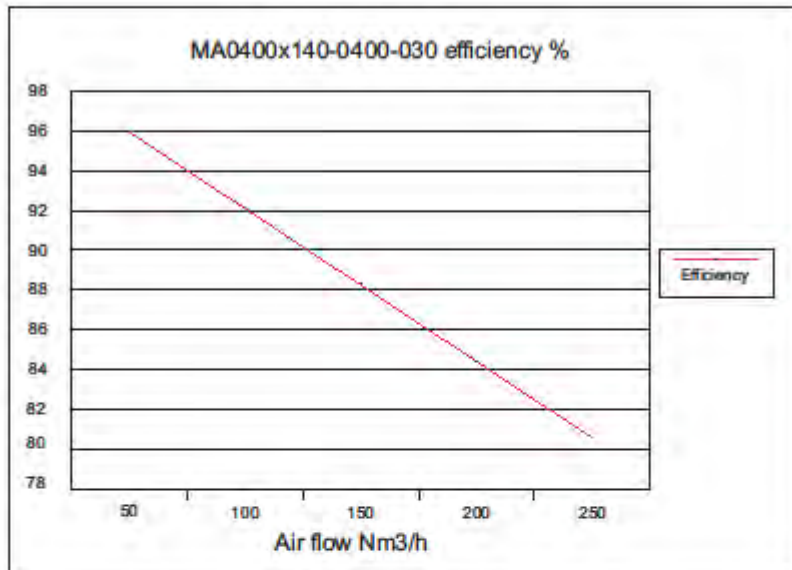

The calculations are made in accordance with the European norm EN 308 and its sub documents.

EXCHANGER



Heatex AB Sweden, Fax: +46-410-363529

Customer:

2009-10-26

Object:

DESCRIPTION

Heat Exchanger:	M?0400x140-0400-030-2A00-2-0-0-3
Plates:	Aluminium or epoxycoated aluminium with turbulence surface.
Sealing:	Silicone free (max 90°C)
Consists of:	1 Module Nominal plate distance: 3.0 mm
Number of steps:	1 Total Width: 400 mm
Total Exchanger Weight:	6.2 kg

RESULT (Winter)

	Exhaust Air	Supply Air
Air flow:	250 Nm ³ /h	250 Nm ³ /h
Pressure drop:	59 Pa	61 Pa
Efficiency:	62.1 %	80.6 %
Transferred Power:	1.74 kW	

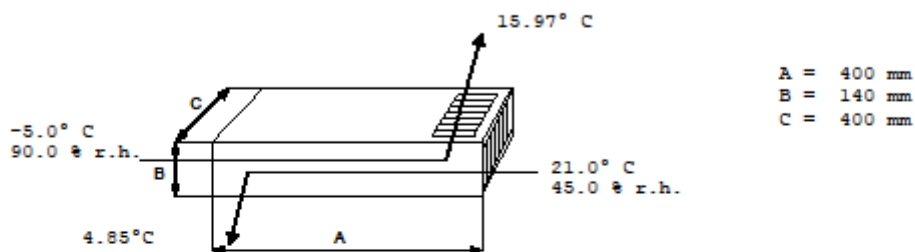

Inlet Pressure: 101325 Pa

Regarding the heat dissipation (transferred power), please take a safety margin of 15 % into consideration, due to uneven airflow

The calculations are made in accordance with the European norm EN 308 and its sub documents.

Owing to continued product development Heatex AB reserves the right to introduce alterations both in design and prices without prior notice.

TX 500A

FLOW-SOUND-ENERGY

TX 500A (Flow - Sound - Energy)

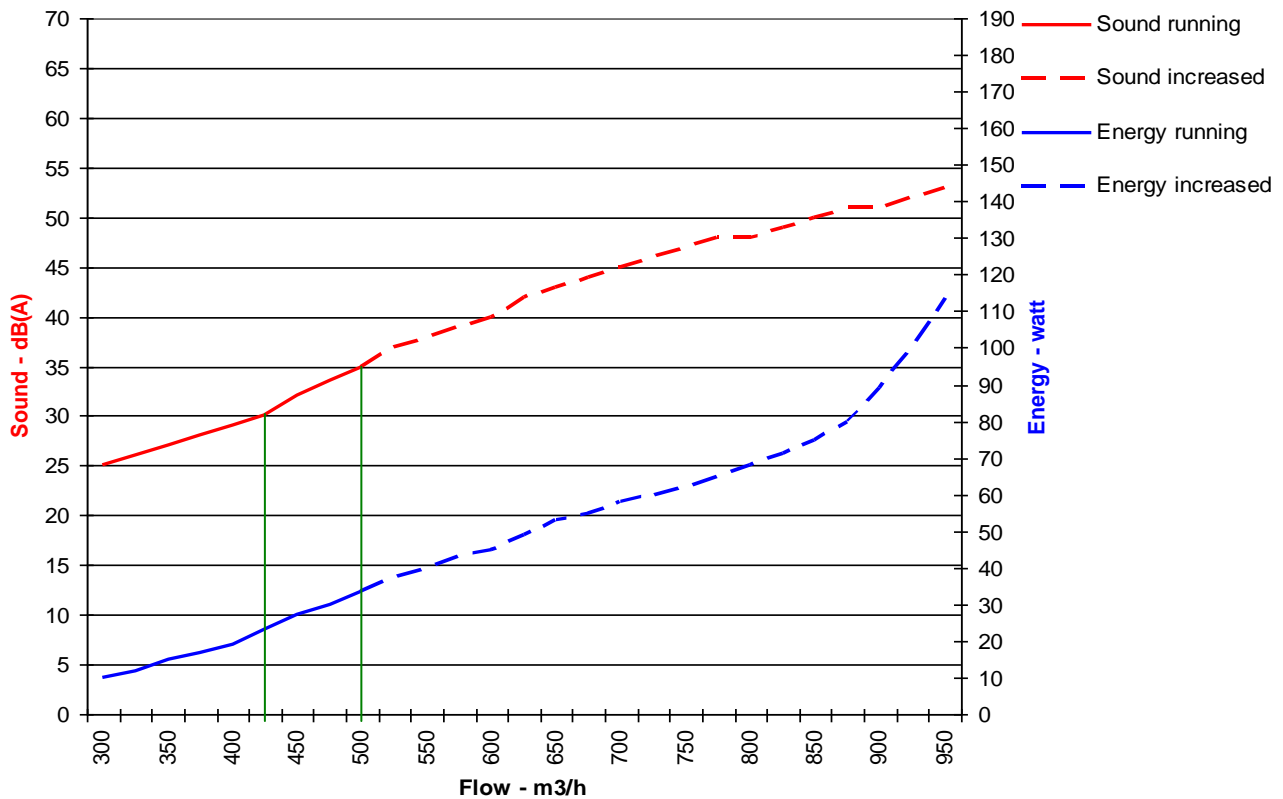

SUPPLY LENGTH

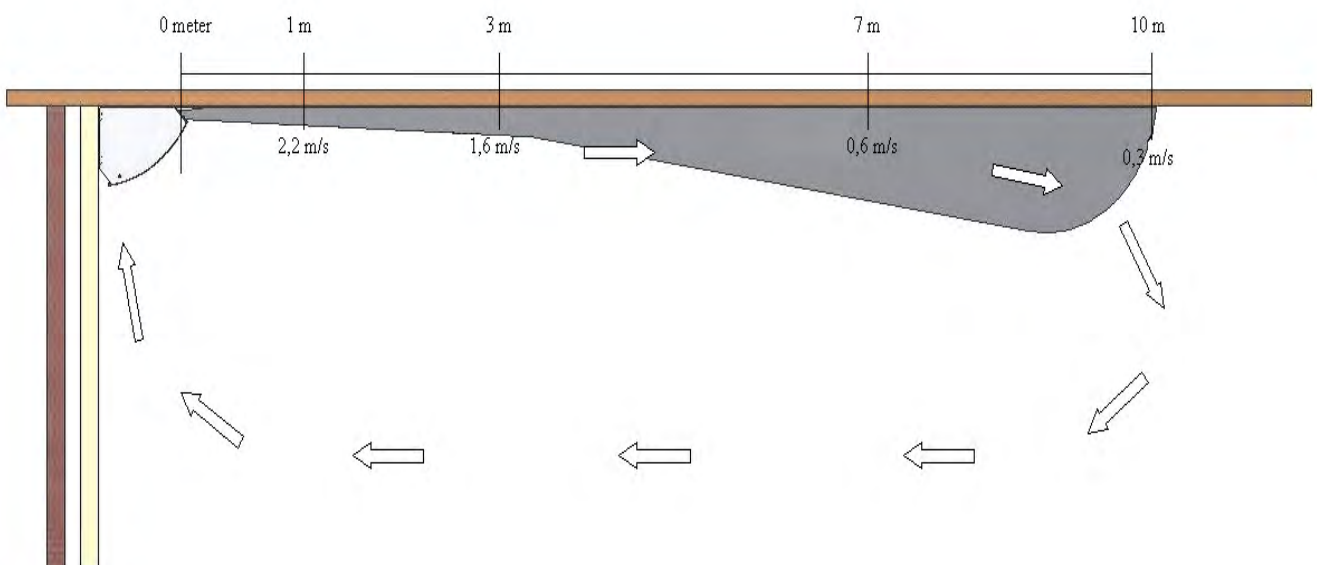

COUNTERFLOW EXCHANGER



TX 500A

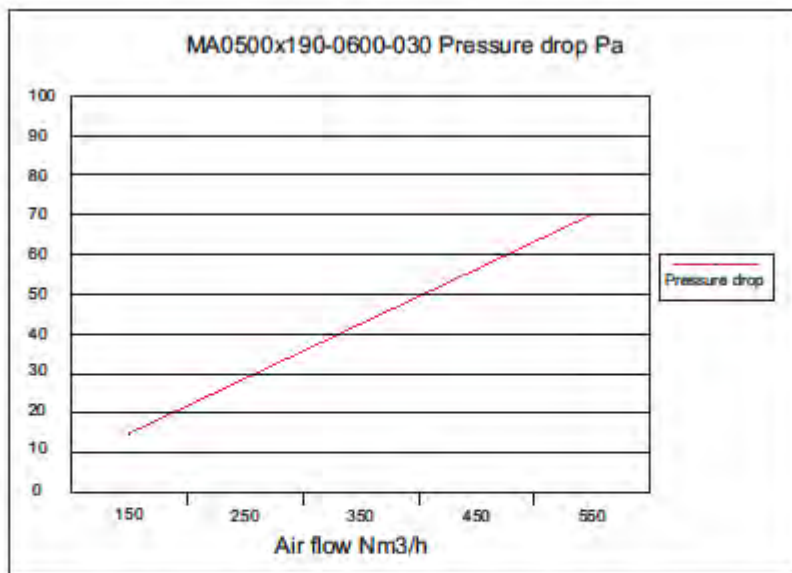
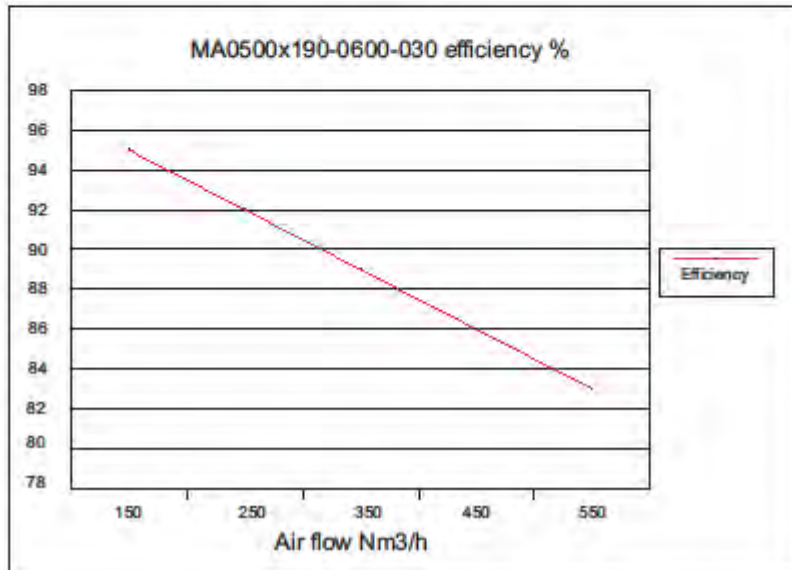

The calculations are made in accordance with the European norm EN 308 and its sub documents.

EXCHANGER



Customer:
Object:

Heatex AB Sweden, Fax: +46-410-363529
2009-12-03

DESCRIPTION

Heat Exchanger: M?0500x190-0600-030-2A00-2-0-0-0
Plates: Aluminium or epoxycoated aluminium with turbulence surface.
Sealing: Silicone free (max 90°C)
Consists of: 1 Module Nominal plate distance: 3.0 mm
Number of steps: 1 Total Width: 600 mm
Total Exchanger Weight: 12.6 kg

RESULT (Winter)

Air flow:	Exhaust Air	Supply Air
Pressure drop:	500 Nm ³ /h	500 Nm ³ /h
Efficiency:	71 Pa	73 Pa
Transferred Power:	64.6 %	84.5 %
	3.65 kW	

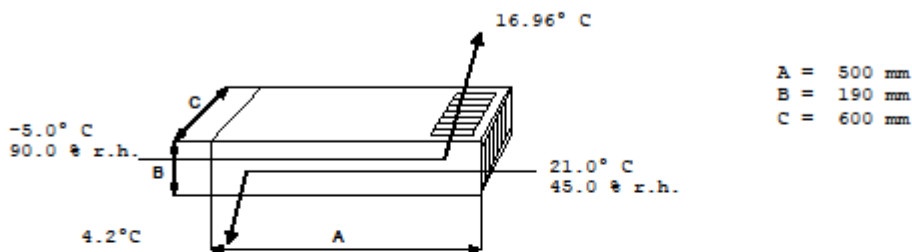

Inlet Pressure: 101325 Pa

Regarding the heat dissipation (transferred power), please take a safety margin of 15 % into consideration, due to uneven airflow

The calculations are made in accordance with the European norm EN 308 and its sub documents.

Owing to continued product development Heatex AB reserves the right to introduce alterations both in design and prices without prior notice.

TX 750A

FLOW-SOUND-ENERGY

TX 750A (Flow - Sound - Energy)

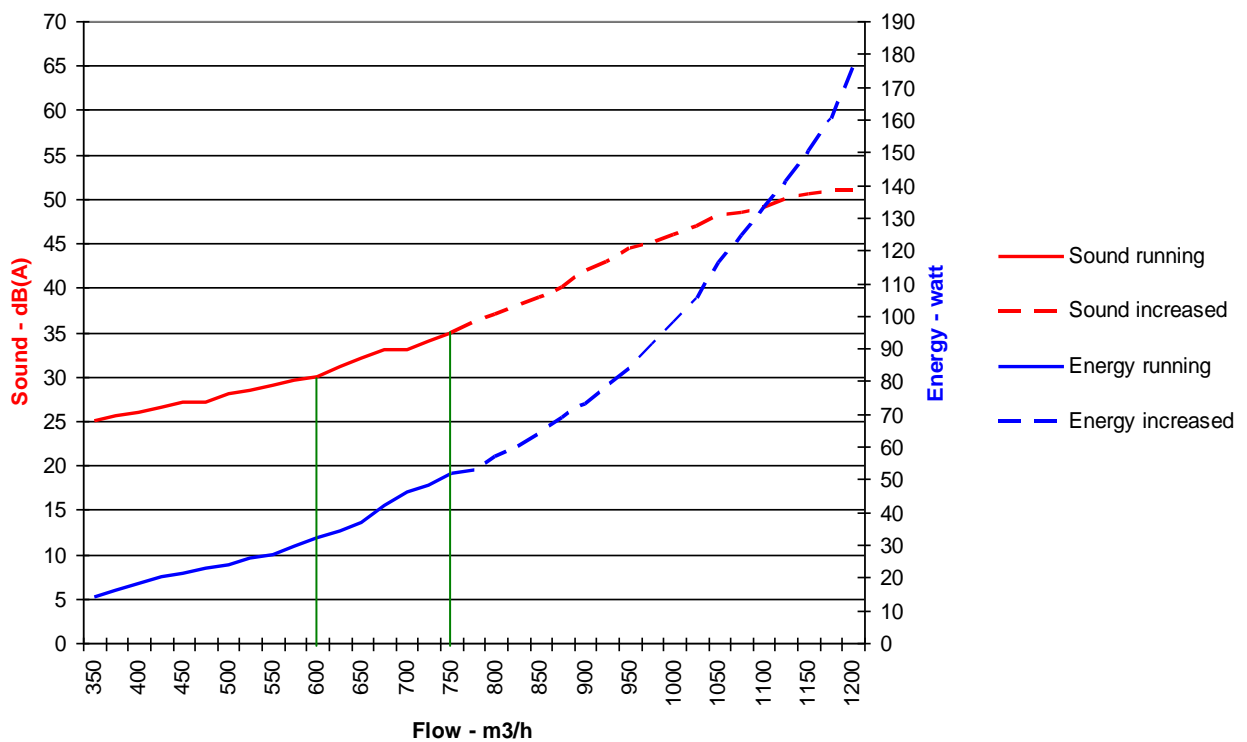

SUPPLY LENGTH

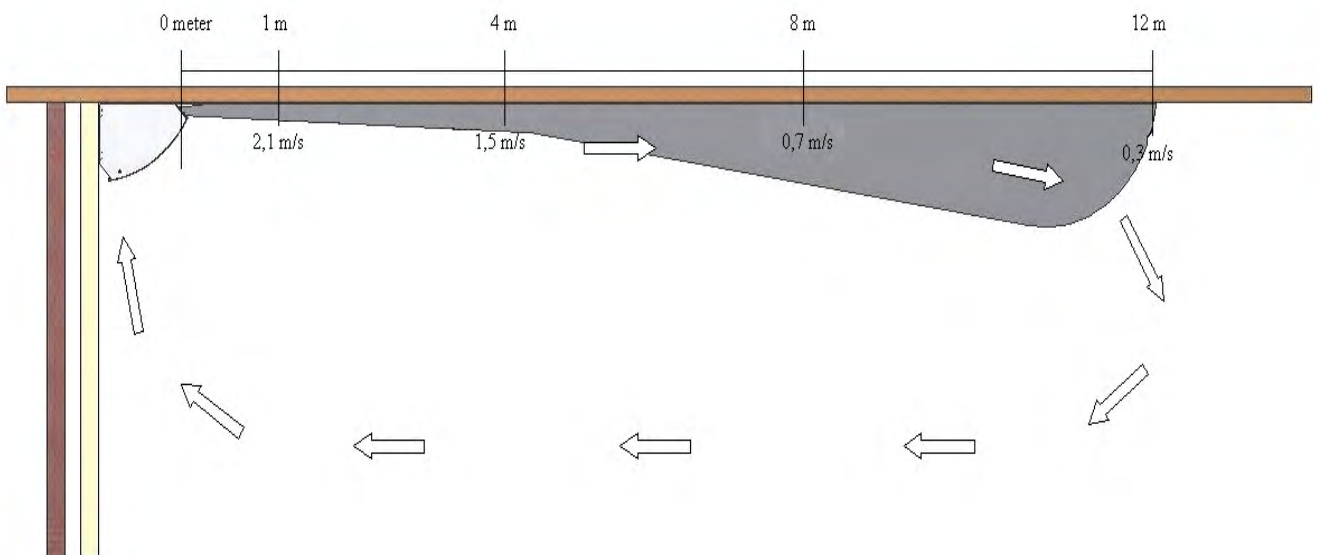

COUNTERFLOW EXCHANGER



TX 750A

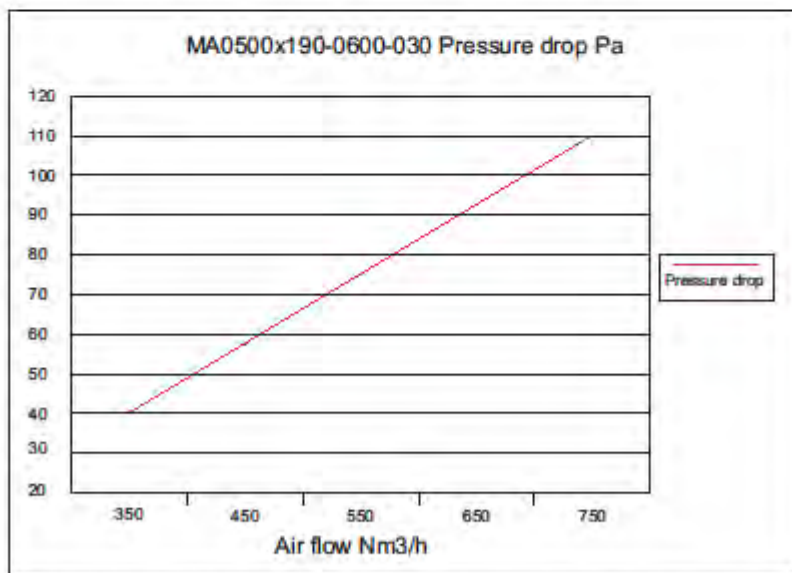
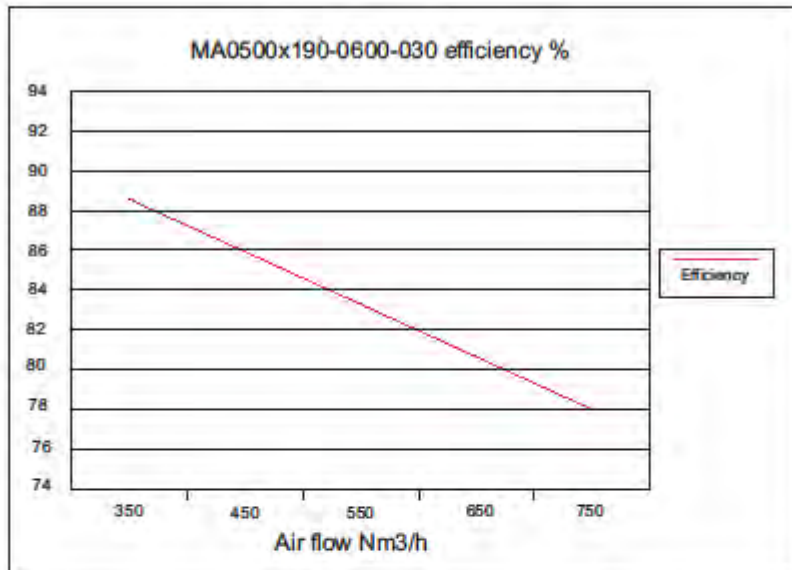

The calculations are made in accordance with the European norm EN 308 and its sub documents.

EXCHANGER



Heatex AB Sweden, Fax: +46-410-363529

Customer:
Object:

2009-12-03

DESCRIPTION

Heat Exchanger: M70500x190-0600-030-2A00-2-0-0-0
Plates: Aluminium or epoxycoated aluminium with turbulence surface.
Sealing: Silicone free (max 90°C)
Consists of: 1 Module Nominal plate distance: 3.0 mm
Number of steps: 1 Total Width: 600 mm
Total Exchanger Weight: 12.6 kg

RESULT (Winter)

	Exhaust Air	Supply Air
Air flow:	750 Nm ³ /h	750 Nm ³ /h
Pressure drop:	116 Pa	119 Pa
Efficiency:	60.4 %	78.0 %
Transferred Power:	5.06 kW	

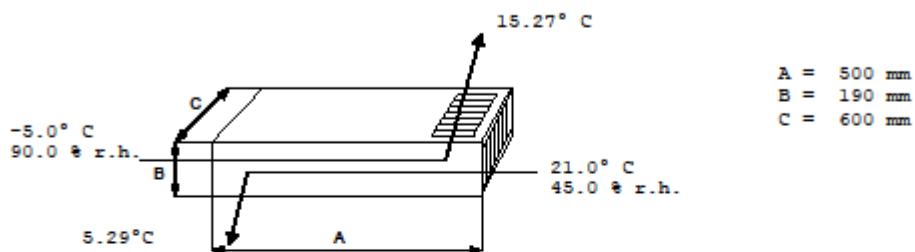

Inlet Pressure: 101325 Pa

Regarding the heat dissipation (transferred power), please take a safety margin of 15 % into consideration, due to uneven airflow

The calculations are made in accordance with the European norm EN 308 and its sub documents.

Owing to continued product development Heatex AB reserves the right to introduce alterations both in design and prices without prior notice.

TX 1000A

FLOW-SOUND-ENERGY

TX 1000A (Flow - Sound - Energy)

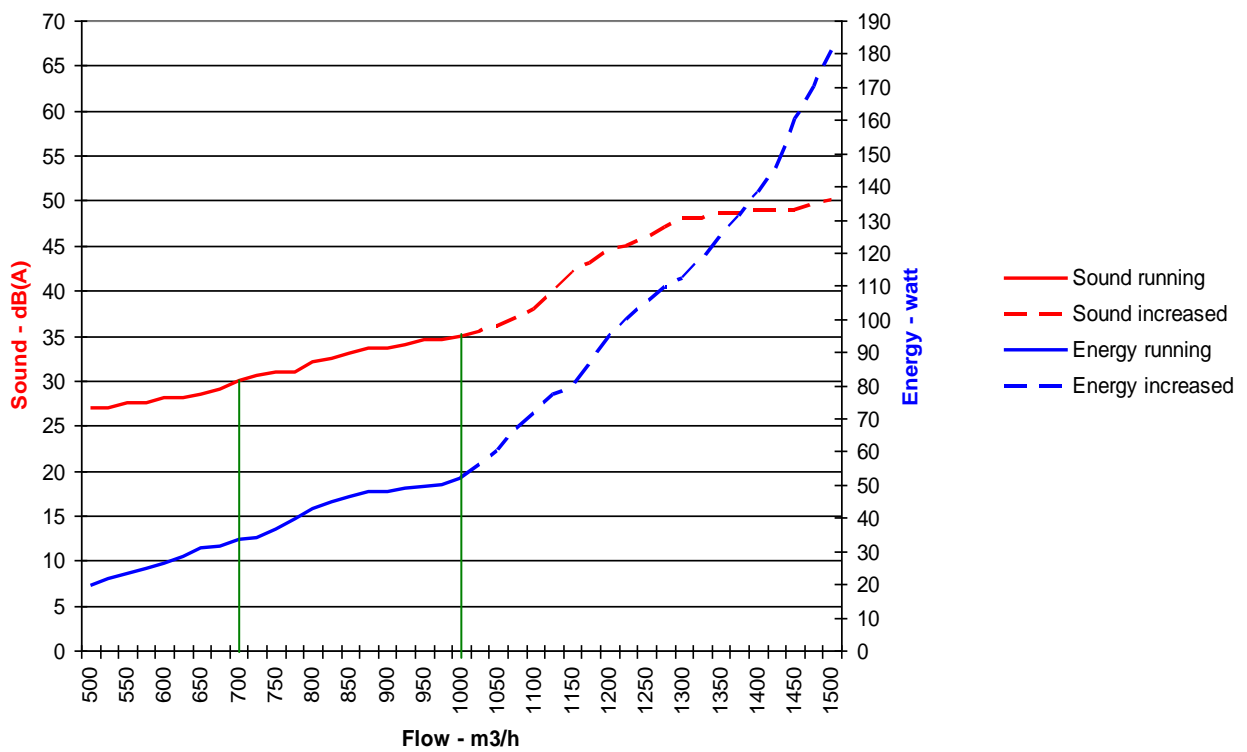

SUPPLY LENGTH

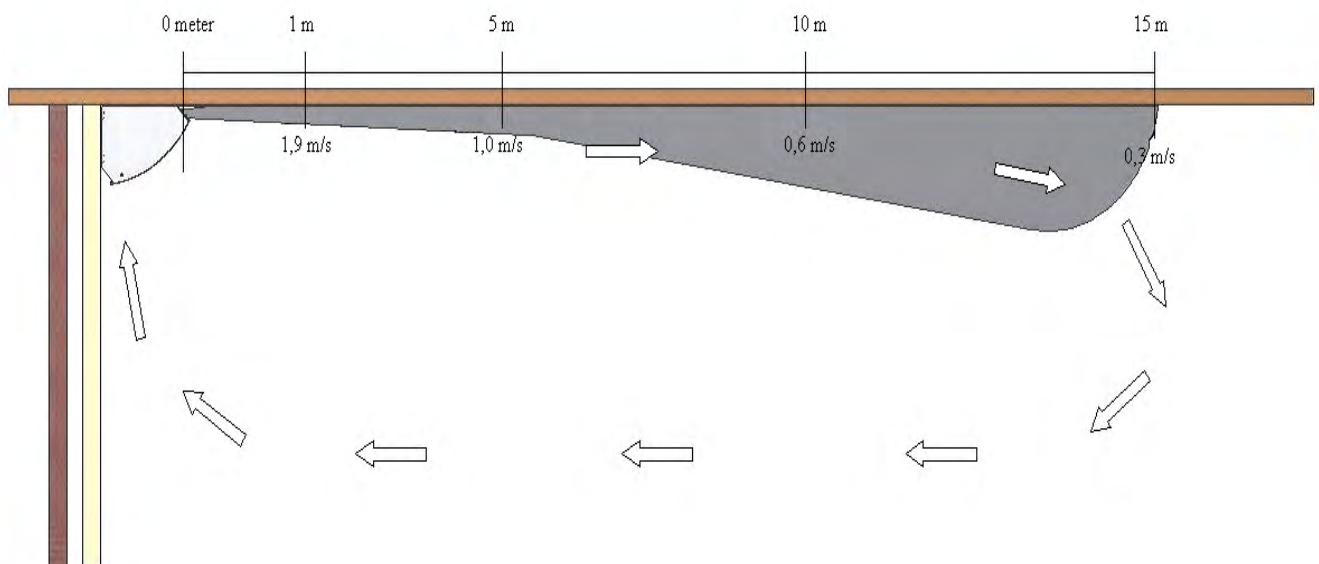

COUNTERFLOW EXCHANGER



TX 1000A

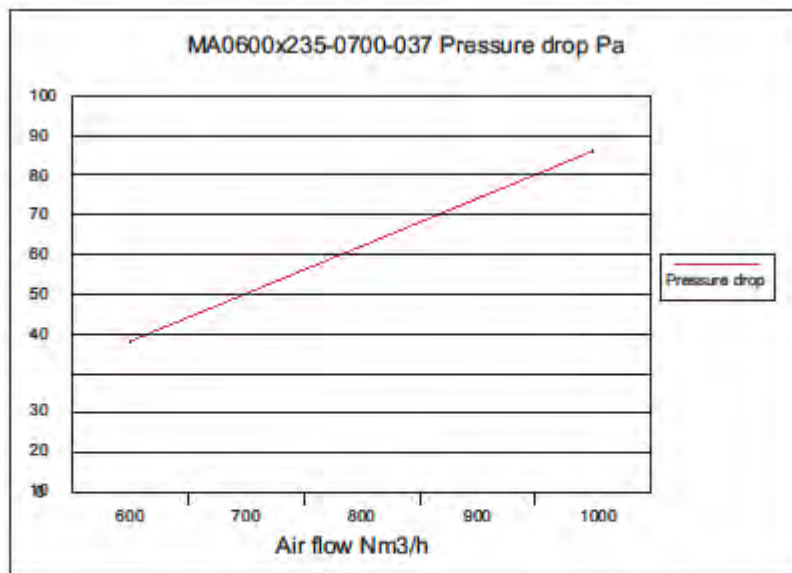
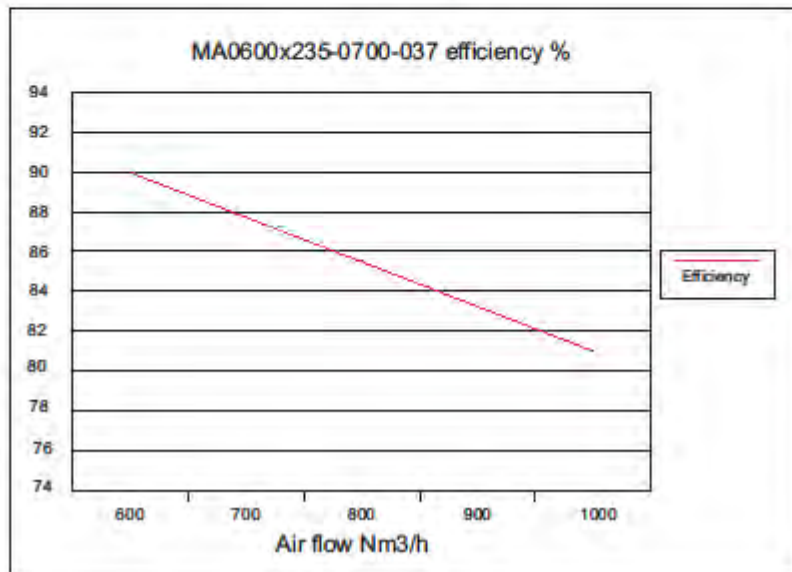

The calculations are made in accordance with the European norm EN 308 and its sub documents.

EXCHANGER



Heatex AB Sweden, Fax: +46-410-363529
2010-12-08

Customer:
Object:

DESCRIPTION

Heat Exchanger:	MA0600x235-0700-037-2A00-2-0-0-0		
Plates:	Aluminium or epoxycoated aluminium with turbulence surface.		
Sealing:	Silicone free (max 90°C)		
Consists of:	1 Module	Nominal plate distance:	3.7 mm
Number of steps:	1	Total Width:	700 mm
Total Exchanger Weight:	18.0 kg		

RESULT(Winter)

	Exhaust Air	Supply Air
Air flow:	1000 Nm ³ /h	1000 Nm ³ /h
Pressure drop:	86 Pa	86 Pa
Efficiency:	63.5 %	80.9 %
Transferred Power:	6.48 kW	

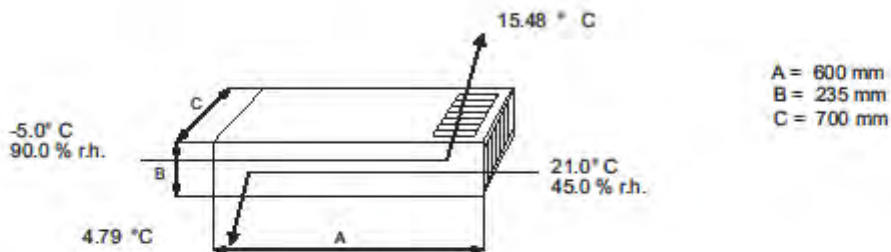

Inlet Pressure: 101325 Pa

Regarding the heat dissipation (transferred power), please take a safety margin of 15 % into consideration, due to uneven airflow

The calculations are made in accordance with the European norm EN 308 and its sub documents.

Owing to continued product development Heatex AB reserves the right to introduce alterations both in design and prices without prior notice.

CONTROL / OPERATION

TX Electronic Control

With TX Electronic Control / display panel , there are many opportunities for individual setup parameters.

- Forced Mode
- Prolonged Mode
- Temperature Setpoints
- Keypad Lock in 4 levels
- Alarm menu
- Software stop
- Day Mode
- Night Mode
- Calendar
- Clock/day/date
- DST Off/on
- Language
- Standby
- PIR
- Technical Menu
- System Info
- others

Master / Slave

The master / slave function allows communication between a unit (master) and up to 5 additional units (slaves 1-5). The master controls the slaves so that all 6 units run in exactly the same way.

The slaves send information back to the master. Any error that might arise in a slave unit will be displayed on the master with an error message and specification of the defective unit. Consequently, all units must be numbered.

This particular master / slave function requires an extra small circuit board for each unit. This small circuit board should be mounted on the existing main circuit board of each unit.

LON

LON (Local Operating Network) is a network where the intelligence is distributed to the devices connected to the system, and not concentrated in a control station as in a traditional network. Thousands of TX plants can be set up on the same network and the wiring can be several kilometers long. In order to use the LON network, install an additional small circuit board on the main board of each unit.

- 4 parameters can be written, 14 parameters can be read

MODbus / RS-485

MODbus is an industrial standard of serial communication for use in client/server communication between devices that can be connected through different networks. 247 TX units can be installed in the same MODbus network and cable length can be up to 500 meters, extended up to 1000 meters at low speed data communication. In order to use the MODbus network, install an additional circuit board on the main board of each plant.

- 16 parameters can be written, 17 parameters can be read

MODbus m/ converter og pc-software

MODbus is an industrial standard of serial communication for use in client/server communication between devices that can be connected through different networks. 200 TX units can be installed in the same MODbus network and cable length can be up to 500 meters, extended up to 1000 meters at low speed data communication. In order to use the MODbus network, install an additional circuit board on the main board of each plant.

- 38 parameters can be read and written

LOCATION

The unit is generally placed on a wall directly under the ceiling. This location best exploits the coanda effect as it leads the air further into the room along the surface of the ceiling. In this way inflowing air can mix with the room's existing air for a longer period of time and thereby prevent draught. This location, as the point for supply and exhaust airflow, provides optimal circulation within a room.

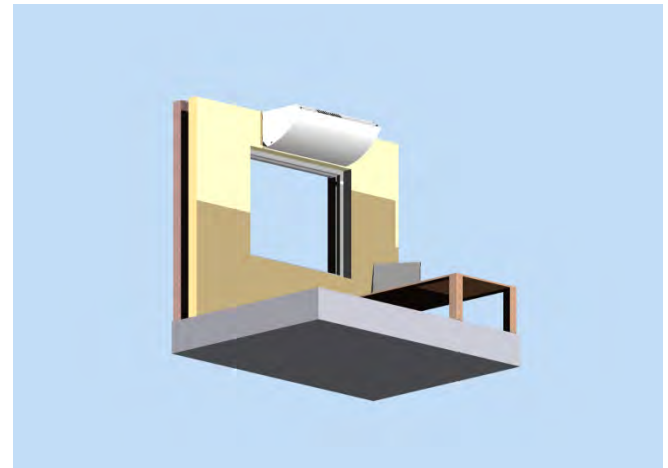
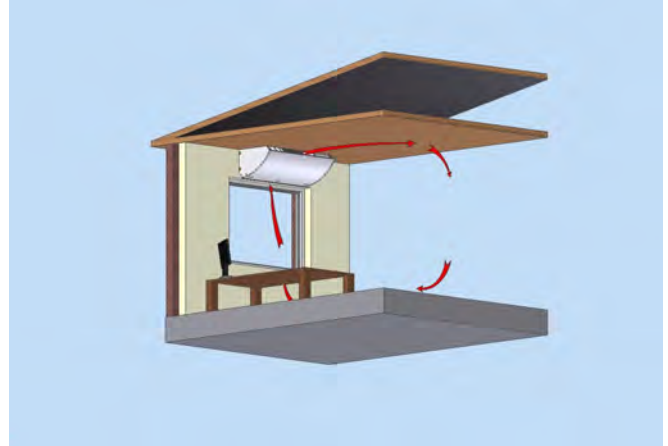
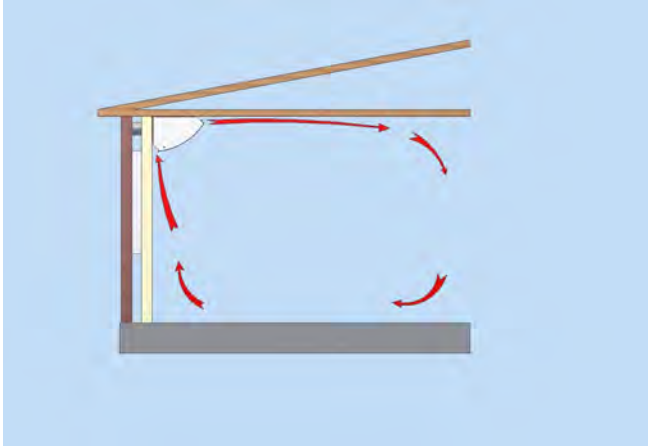

LOCATION IN A FALSE CEILING

The TX Comfort series also has the possibility of locating the unit in false ceilings. In this way, the unit is less visible.

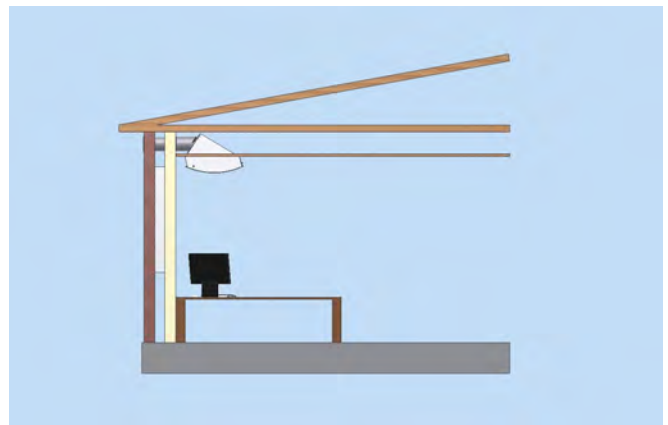
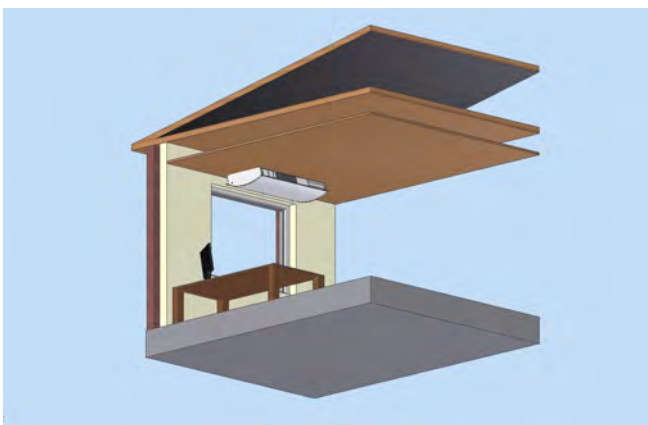

OPTION FOR TX COMFORT

	TX 250A	TX 500A	TX 750A	TX 1000A
TX Electronic Controller	○	○	○	○
CO ₂ sensor T8100-E-D with display	○	○	○	○
CO ₂ sensor T8031 built in	○	○	○	○
Hygrostat	○	○	○	○
PIR Sensor	○	○	○	○
Temperature Sensor	●	●	●	●
LON Interface	○	○	○	○
Master/Slave print	○	○	○	○
MODbus print	○	○	○	○
MODbus Converter incl. Software	○	○	○	○
M5 Filter	●	●	●	●
F7 Filter	○	○	○	○
Fittings for installation in false ceiling	○	○	○	○
Angle brackets for install. in false ceiling	○	○	○	○
Combi Right/Left	○	○	○	○
Condensation pump	○	○	○	○
Condensation tray	○	○	○	○
Automatisk by-pass	●	●	●	●
Modulating by-pass	○	○	○	○
Motorized back draft shutter-return	○	○	○	○
Electric heater	○	○	○	○
Water heating battery	○	○	○	○
Counter flow heat exchanger (alu)	●	●	●	●
Mounting Brackets	●	●	●	●
Tubes	○	○	○	○
Gratings	○	○	○	○
Color RAL 9010	●	●	●	●
Other RAL color	○	○	○	○
Filter Alarm	●	●	●	●

- Standard
- Option
- Not possible

SEE MORE DETAILS ON www.turbovex.dk



Turbovex A/S
Industrivej 45
DK-9600 Aars

Tel. +45 96 98 14 62
info@turbovex.dk
www.turbovex.dk